

<p>DO NOT SCALE DRAWING UNLESS OTHERWISE SPECIFIED ALL DIMENSIONS ARE IN MILLIMETERS TOLERANCES ARE: LINEAR TOL: .X=±1.0 .XX=±0.5 ANGULAR TOL: ±1°</p>						MODEL	PROJECTION
						TM-2239	
						DESCRIPTION	SIZE: A4
						22" SAW touchmonitor	SCALE 1:1
						MATERIAL	WEIGHT:
							20 Kg
						FINISH	COLOR:
							BLACK
A	FIRST ISSUE	09-10-14	Sara	David	CLOUD	DRAWING NO.:	
REV.	DESCRIPTION	DATE	DRAW	CHECK	APPROVE	SHEET 1 OF 3	

I H G F E D C B A

SIDE MOUNT, HORIZONTAL

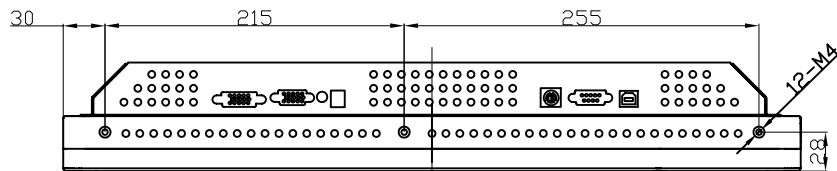

VESA

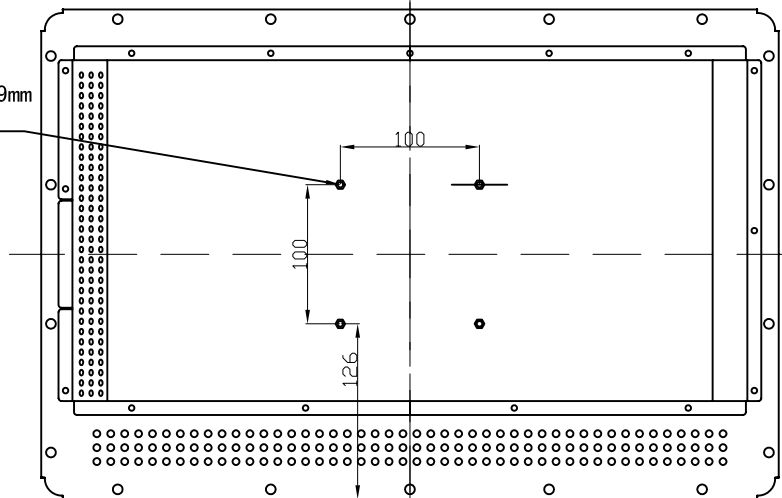

M4 THREAD
MAX. SCREW DEPTH=5mm
12X

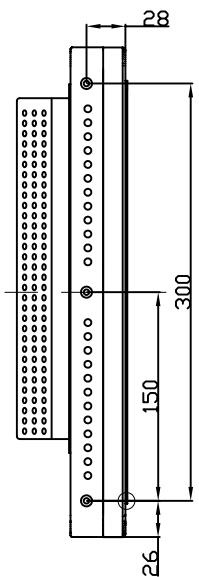

SIDE MOUNT, VERTICAL

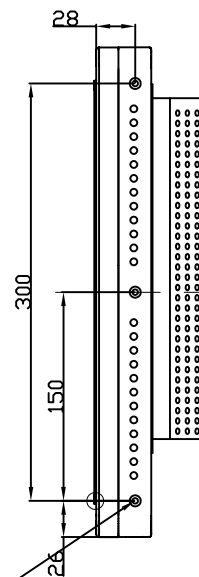

SIDE MOUNT, VERTICAL

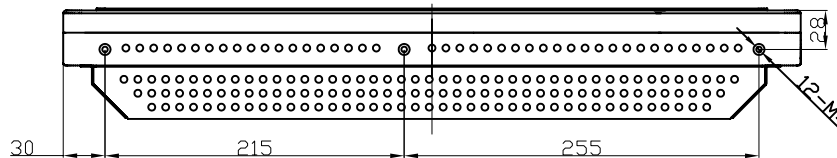

SIDE MOUNT, HORIZONTAL

A	FIRST ISSUE	09-10-14	Sara	David	CLOUD
REV.	DESCRIPTION	DATE	DRAW	CHECK	APPROVE

Leading Touch
DO NOT SCALE DRAWING UNLESS OTHERWISE SPECIFIED
ALL DIMENSIONS ARE IN MILLIMETERS
TOLERANCES ARE:
LINEAR TOL: .XX=±1.0
.XX=±0.5
ANGULAR TOL: ±1°
DRAWING NO.:

MODEL	TM-2239
DESCRIPTION	22" SAW touchmonitor
MATERIAL	
FINISH	

PROJECTION	
SIZE:	A4
SCALE	1:1
WEIGHT:	20 Kg
COLOR:	BLACK

REAR MOUNT WITH BRACKETS,
HORIZONTAL AND VERTICAL

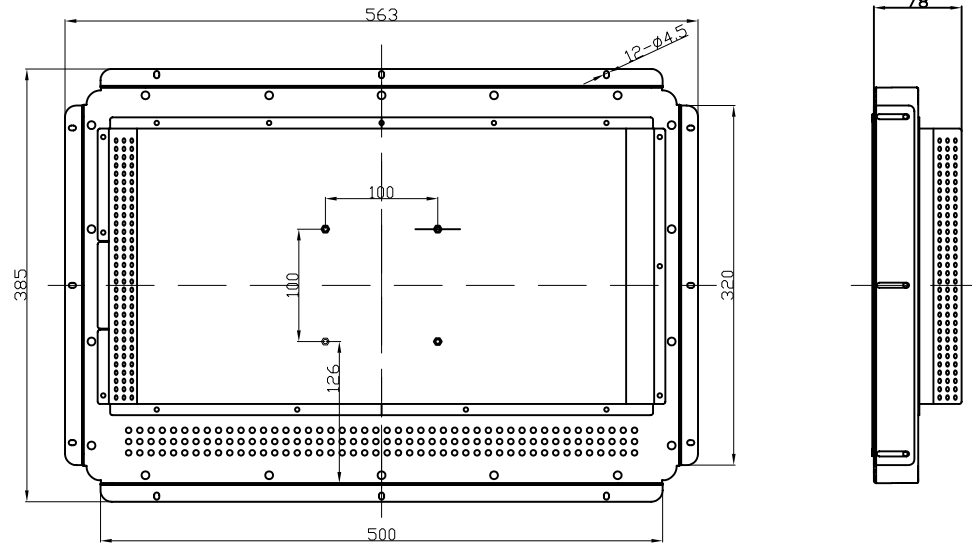

RECOMMENDED CUSTOMER PANEL
CUT-OUT

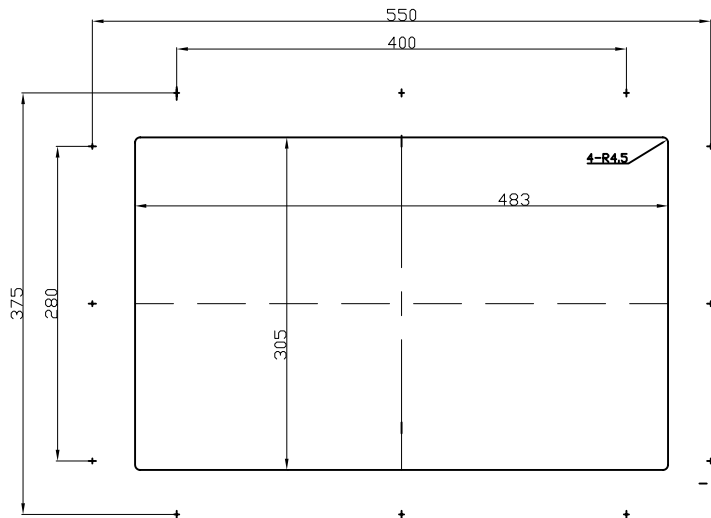

						<p>DO NOT SCALE DRAWING UNLESS OTHERWISE SPECIFIED ALL DIMENSIONS ARE IN MILLIMETERS TOLERANCES ARE: LINEAR TOL: .XX=±1.0 .XX=±0.5 ANGULAR TOL: ±1°</p>	MODEL TM-2239	PROJECTION
							DESCRIPTION 22" SAW touchmonitor	SIZE: A4 SCALE 1:1
							MATERIAL	WEIGHT: 20 Kg
							FINISH	COLOR: BLACK
A	FIRST ISSUE	09-10-14	Sara	David	CLOUD	DRAWING NO.:	SHEET 3 OF 3	REV. A
REV.	DESCRIPTION	DATE	DRAW	CHECK	APPROVE			