

22" Rear Mount Touchmonitor

TM-2234

Features

- Rear Mount
- Slim profile with unique narrow border
- Multiple mounting options
- Rear-mount VESA mounting option and removable wing bracket for VESA
- Detachable cables for easy cable harnessing
- Single power supply for all optional devices
- Multilingual and detachable On Screen Display (OSD)
- Comb Serial and USB touch interface
- Super-sensitive, drift-free, precise touch with no overlay
- Long-lasting product cycle
- Worldwide agency approvals



22" Rear Mount Touchmonitor

TM-2234

Leadingtouch Rear Mount LCD's touchmonitors are designed for easy integration into kiosk, gaming machine, industrial enclosure and other installations where compact, touch-integrated display are preferred. TM-223 series integrate the Leadingtouch's IP65 level SAW, 4-Wire resistive, 5-Wire resistive or capacitive touchscreen, TM-223 series is Dustproof and Waterproof touchmonitors.

TM-223 series are designed for space saving and easy mounting integrations. The rear-mount configuration along with optional side mounting brackets would enable you to easily customize into kiosks, cabinets, in-wall as well as other enclosures.

TM-223 series will have Leadingtouch Combo controller with dual touch ports for convenience and flexibility. It will enable you to use both the



Product Information

P/N	Touch Technology
TM-2239	SAW touchscreen
TM-2237	Capacitive touchscreen
TM-2234	4 Wire Resistive touchscreen
TM-2235	5 Wire Resistive touchscreen

Specifications

Model	TM-2234
Description	22" wide screen TFT Rear Mount Touchmonitor
Case/Bezel Color	Plastic / Black
Display	16:10 Ratio Active matrix TFT LCD
Optimal(native) resolution	1680 x 1050 @ 60Hz
Synchronization Range	72.1 KHz horizontal, 60 Hz vertical
Useful screen area	Horizontal: 18.66" (474 mm); Vertical: 11.65" (296 mm)
Colors	16.7 million
Brightness	LCD panel: 300cd/m2 (typical) With touchscreen: 280 cd/m2 (typical)
Pixel Pitch	0.282 x 0.282 mm
Response Time	5 msec (typical)
Contrast ratio	1000:1 typical
Viewing angle(typical, from center)	Horizontal (left/right): 170°(85° /85°) Vertical (up/down): 160°(80° /80°)
Backlight Lamp life	50,000 Hrs to 1/2 brightness
Input video format	Analog (VGA) and DVI
Input video signal connector	Analog (VGA) and DVI
On Screen Display(OSD)	Remote OSD with 1.2m Cable
Touch Technology	4-Wire resistive
Touch Interface	Combo 10ms 232 and USB interface
Touch Resistive Time	10ms
Mounting Options	Rear Fixed, 100mm VESA mount
Power supply	External:100-240V AC, 50-60 Hz
Power Consumption	31W Typical
Temperature Range	Operating:0° C-50° C, Storage:-20° C-60° C
Humidity Range	Operating:8%-90%, Storage 5%-90%
Touchmonitor Dimension	530 x 352 x 79.4(mm)
Shipping Carton Dimension	630x 452 x 190(mm)
Weight(approx.)	Monitor:7kg / shipping: 10kg
Warranty	Monitor: 3 years'; LCD Panel: 1 year
Agency Approvals	FCC, CE, RoHS compliant



22" Rear Mount Touchmonitor

TM-2234

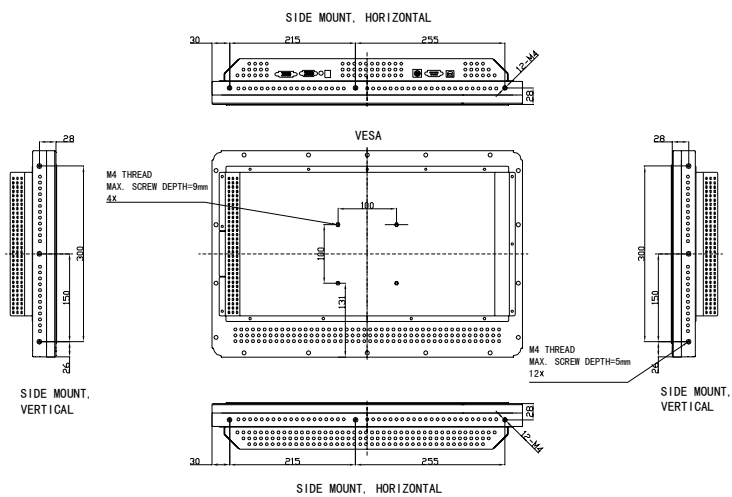
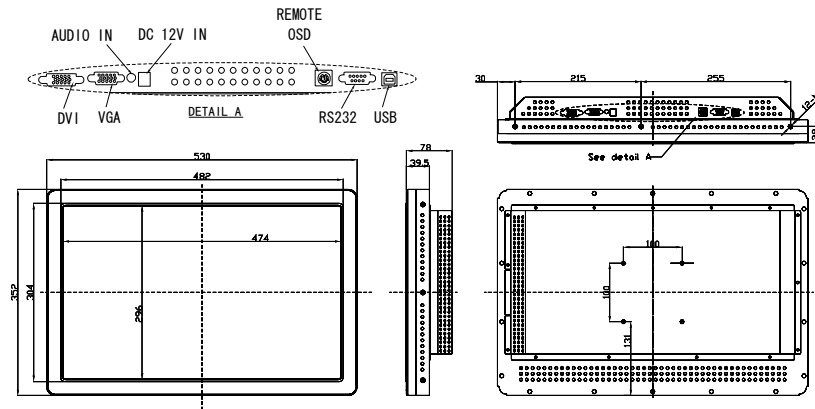

REAR MOUNT WITH BRACKETS,
HORIZONTAL AND VERTICAL

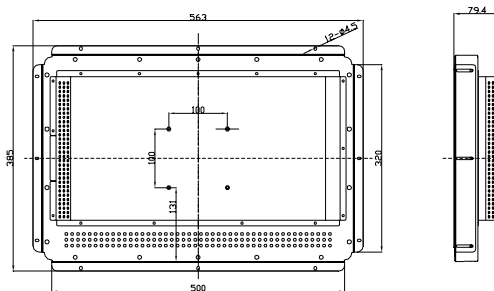

RECOMMENDED CUSTOMER PANEL
CUT-OUT

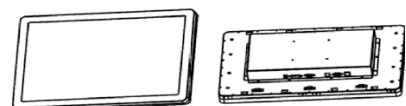
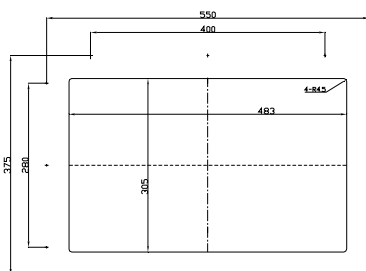

22" Rear Mount Touchmonitor

TM-2234

Optional Accessory: Remote OSD Controller Box

