



17" Open Frame Touchmonitor

TM-1755

Features

- Open Frame
- Slim profile with unique narrow border
- Multiple mounting options
- Open-Frame VESA mounting option and removable wing bracket for VESA
- Detachable cables for easy cable harnessing
- Single power supply for all optional devices
- Multilingual and detachable On Screen Display (OSD)
- Comb Serial and USB touch interface
- Super-sensitive, drift-free, precise touch with no overlay
- Long-lasting product cycle
- Worldwide agency approvals



17" Open Frame Touchmonitor

TM-1755



Leadingtouch Open Frame LCD's touchmonitors are designed for easy integration into kiosk, gaming machine, industrial enclosure and other installations where compact, touch-integrated display are preferred.

TM-175 series integrate the Leadingtouch's IP65 level SAW, Resistive, Capacitive or Infrared touchscreen, TM-175 series is Dustproof and Waterproof touchmonitors.

TM-175 series are designed for space saving and easy mounting integrations. The Open-frame configuration would enable you to easily customize into kiosks, cabinets, in-wall as well as other enclosures.

TM-175 series will have Leadingtouch Combo controller with dual touch ports for convenience and flexibility. It will enable you to use both the Serial RS-232 as well as USB port for your touchscreen application

Product Information

P/N	Touch Technology
TM-1759	SAW touchscreen
TM-1758	Infrared touchscreen
TM-1757	Capacitive touchscreen
TM-1754	4 Wire Resistive touchscreen
TM-1755	5 Wire Resistive touchscreen



Specifications

Model	TM-1755
Description	17" TFT Open Frame Touchmonitor
Case/Bezel Color	Black
Display	4:3 Ratio Active matrix TFT LCD
Optimal(native) resolution	1280X1024@60Hz
Synchronization Range	Horizontal:30-80 kHz; Vertical: 60-75Hz
Useful screen area	Horizontal: 13.3" (338 mm);Vertical: 10.6" (270 mm)
Colors	16.7 million
Brightness	LCD panel: 300cd/m2 (typical) With touchscreen: 280 cd/m2 (typical)
Pixel Pitch	0.264 x 0.264 mm
Response Time	8 msec (typical)
Contrast ratio	500:1 typical
Viewing angle(typical, from center)	Horizontal (left/right): 140°(70° /70°) Vertical (up/down): 130°(70° /60°)
Backlight Lamp life	50,000 Hrs to 1/2 brightness
Input video format	VGA or DVI optional
Input video signal connector	Mini D-Sub 15-Pin VGA type
On Screen Display(OSD)	Remote OSD with 1.2m cable
Touch Technology	5W Resistive(Infrared, SAW, Resistive, Capacitive Optional)
Touch Interface	Combo 10ms232 and USB interface
Touch Resistive Time	10ms
Mounting Options	Rear Fixed, 75 mm & 100mm VESA mount
Power supply	External:100-240V AC, 50-60 Hz
Power Consumption	50W max
Temperature Range	Operating: 0°C to 50°C; Storage: -20°C to 60°C
Humidity Range	Operating: 10%-90%; Storage: 5%-90% no condensing
Touchmonitor Dimension	407x 339 x 76(mm)
Shipping Carton Dimension	460x 409 x 175(mm)
Weight(approx.)	Monitor: 4kg / shipping: 6kg
Warranty	Monitor: 3 years'; LCD Panel: 1 year
Agency Approvals	FCC, CE, RoHS compliant

17" Open Frame Touchmonitor

TM-1755

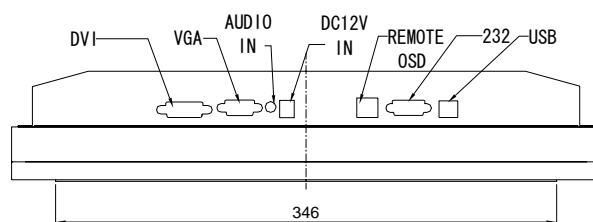
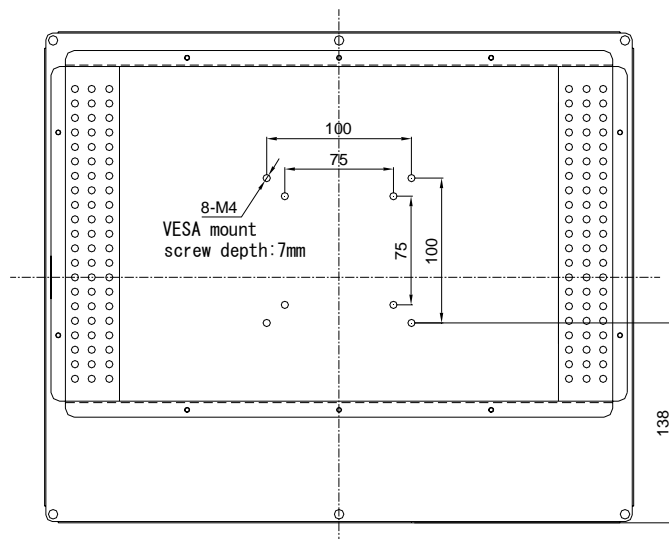
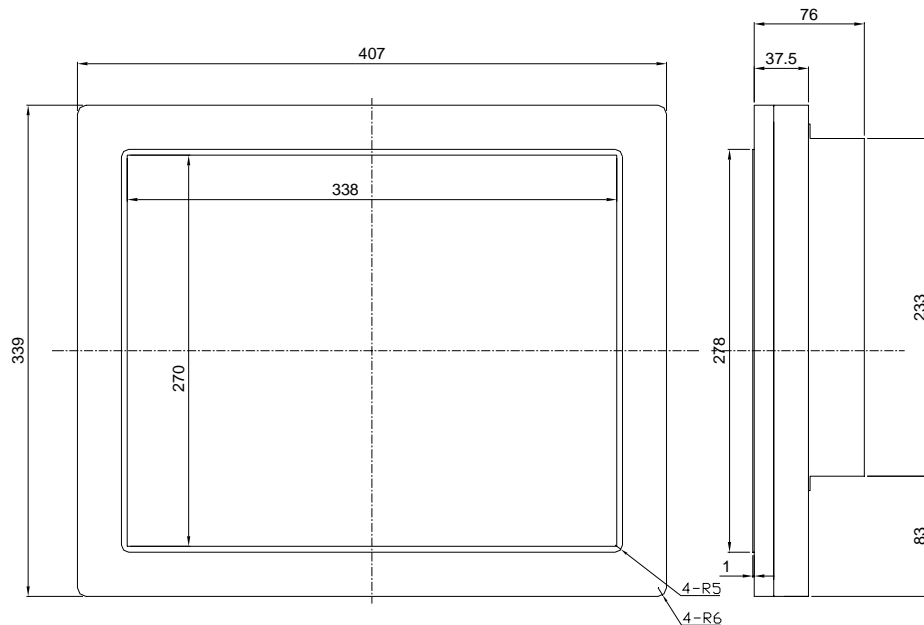

17" Open Frame Touchmonitor

TM-1755

Optional Accessory: Remote OSD Controller Box

