

5030S Controller User manual

Version 1.01

Copyright ©2009-2010

by

Leadingtouch Technology Co., Ltd

HuiLongGuan LongXiang industrial center, ChangPing, Beijing, China

Tel: +86-51090978 <http://www.leadingtouch.com>

Fax: +86-51090979 E-mail: info@leadingtouch.com

Content

CONTENT	2
1 PRECAUTIONS	3
2 PACKAGE CONTENTS	3
3 INSTALLING AND CONNECTING.....	4
4 PHYSICAL CHARACTERISTICS	5
CONSTRUCTION	5
DIMENSIONS	5
5 ELECTRICAL.....	5
SUPPLY VOLTAGE AND CURRENT	5
SERIAL INTERFACE	5
BAUD RATE	6
OPERATING MODES	6
TOUCH RESOLUTION	6
CONVERSION TIME.....	6
RELIABILITY	6
6 ENVIRONMENTAL	6
TEMPERATURE	6
HUMIDITY	6
OPERATING ALTITUDE	7
SHOCK AND VIBRATION	7
ESD: CONTROLLER ALONE	7
7 LED INDICATORS.....	7
8 CONNECTORS AND SIGNAL DESCRIPTIONS.....	8
POWER/INTERFACE CONNECTOR	8
TOUCHSCREEN CONNECTOR	9
9 AGENCY APPROVALS	10
10 INSTALLING DRIVER.....	10
11 FAQ.....	20

1 PRECAUTIONS

Touchscreen is made of glass material. It's easily breakable from dropping or impact, please handle it with care.

Please pull the plug and contact the sales dealer immediately when you smell a bit of unpleasant odor out of touchscreen.

Please do not plug-in and plug-out frequently when the computer is on.

Please clean the front and rear surface of touchscreen in order to make it best performance.

Please do not screw it tight when mounting the touchscreen (i.e. it is desirably fixed up) for fear of deformation.

Please contact the sales dealer if there are not adequate components to your touchscreen.

New touch screen system comprising of: package contents including touchscreen and PC connection cables, control card, quality-assured card, installation disc including driver and manual.

2 Package contents

Touchscreen

PC connection cables

Control card

(USB, serial or Comb cable, depending on the model you chose)

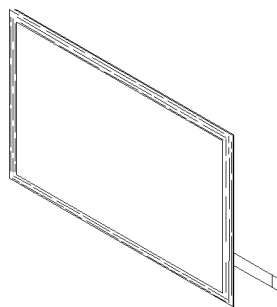

Touchsreen

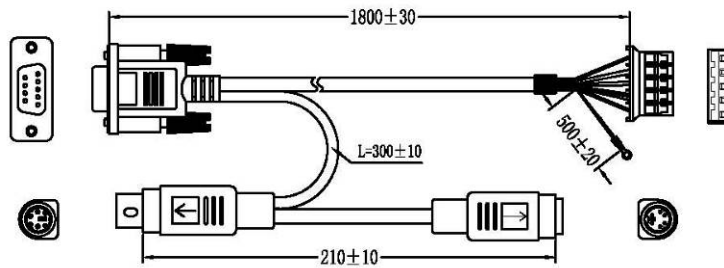

Standard 232 connector cable 14-111-180

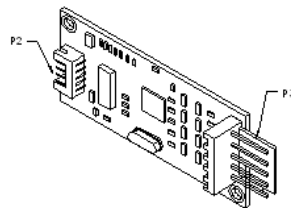

Control card 5030S

3 Installing and connecting

Mount touchscreen on monitor and then connect it to PC with cable and control card as following steps

Serial cable connecting

- 1 · Connect touchscreen 5pin port to 5pin connector of control card.
- 2 · Connect cable 14-111-180 5 pin connector to 5pin connector of control card.
- 3 · Connect 14-111-180 DB9 port to PC DB9 port.
- 5 · Connect 14-111-180 PS/2 male port to PC PS/2 female port.
- 6 · If your mouse is PS/2 interface and there is no port on PC to connector your mouse, connect PC mouse PS/2 male port to 14-111-180 PS/2 female port.

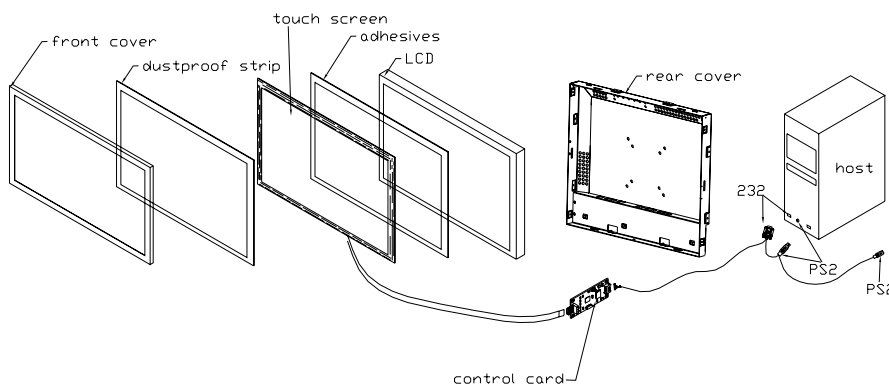

4 Physical Characteristics

Construction

- Four-layer surface-mount design with internal ground plane for EMI suppression.

Dimensions

- Total width: 0.79 inches (20 mm), including connectors
- Total length: 2.84 inches (72 mm)
- Total height: 0.32 inches (8 mm)
- All mounting holes are plated through for chassis ground connection.

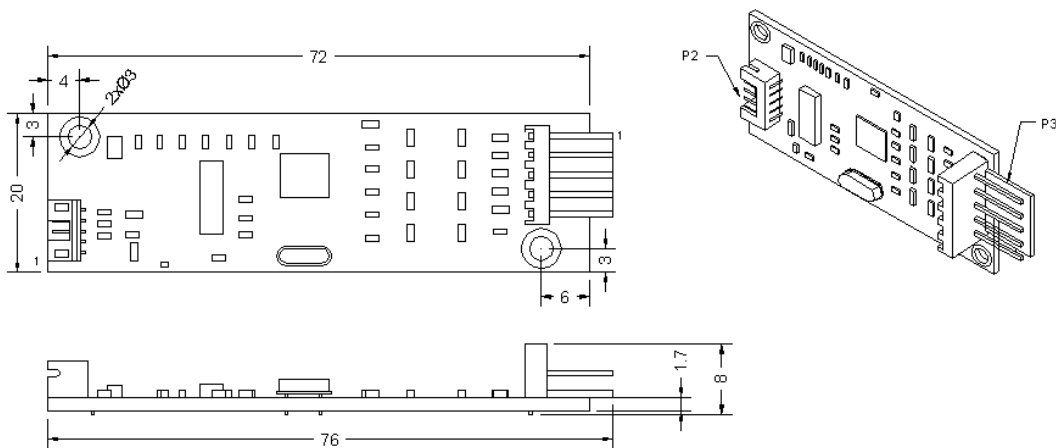

5 Electrical

Supply Voltage and Current

- +5 VDC, nominal (+4.50 VDC to +5.25 VDC).
- 50 mA standby, typical at +5 VDC; during touch 160 mA average, 240 mA peak
- Average power dissipation is 0.5 W, typical
- Supply must be capable of sourcing 400 mA, minimum
- Total noise and ripple requirement must be less than 100mV (p-p) for frequencies bleedingtouchw 1MHz, and less than 50mV (p-p) for frequencies above 1MHz.

Serial Interface

- EIA 232E (Serial RS-232), DCE configuration. 8 Data Bits, 1 Stop Bit, No Parity, Full Duplex

- Hardware handshaking: CTS

Baud Rate

- 9600

Operating Modes

- Leadingtouch protocol
- Customer specific protocol
- Initial/ Stream/ Untouch Modes

Touch Resolution

- 4096x4096, size independent

Conversion Time

- Approximately 10 ms per coordinate set

Reliability

Calculated MTBF is shown as following:

MTBF Method and Temperature	Calculated MTBF
MIL-HDBK-217-F2, ground benign, 25°C	622,699
MIL-HDBK-217-F2, ground benign, 35°C	490,283
Bellcore, 25°C	1,675,705
Bellcore, 35°C	1,294,588

6 Environmental

Temperature

- Operating: 0°C to 65°C
- Storage: -25°C to 85°C

Humidity

- Operating: 10% to 90% RH, noncondensing
- Storage: 10% to 90% RH, noncondensing

Operating Altitude

- 10,000 feet

Shock and Vibration

- The controllers, with Leadingtouch standard container, can meet International Safe Transit Association project 2A test procedure.

ESD: Controller Alone

- Per EN 6100-4-2 1995. Level 4
- Contact Discharge - 8kV
- Air Discharge - 15kV positive and negative polarity
- Applied directly to P2 Serial port via a 560 ohm resistor and a 10" wire

Table 1 P2 Pins for ESD Testing

P2 Pin	Signal Name	Signal Function	P2 Pin	Signal Name	Signal Function
1	CTS	Serial Port	2	TxD	Serial Port
3	RxD	Serial Port	4	GND	Ground

The controller may not function correctly after test, however, it should work normally after reset or recycle of the supply. The ESD tests will be conducted with the controller integrated into a monitor with the controller and the ESD generator grounded to the monitor chassis

Flammability

- The PCB substrate is rated 94V0. All plastic components, such as headers and connectors, are also rated 94V0.

7 LED Indicators

The 5030S controller has one LED status indicators. When 5030S controller initially connects to host, the LED will be constantly on. Then when touchscreen connects to 4030U, the LED will snuff out after 3 seconds and be constantly on during touch.

8 Connectors and Signal Descriptions

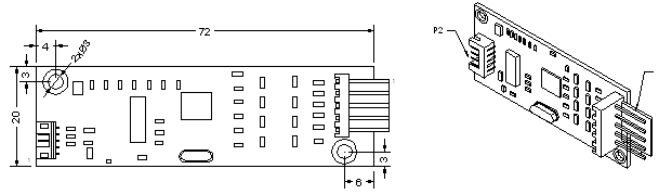

CONNECTOR P2

PIN #	SIGNAL NAME
1	CTS
2	TXD
3	RXD
4	GND
5	+5V

CONNECTOR P3

PIN #	SIGNAL NAME
1	H
2	X
3	S
4	Y
5	L

All connectors are located along one side of the controller. Connector descriptions and pin definition are as following sections.

Power/Interface Connector

The power/interface connector, P2, is a 2.0mm pitch 5 pin connector, intended to be used with single wired pins in a 5 pin header. The pins are numbered as shown in Table 1.

Table 1 Power/Interface Connector P2 Pin Numbers and Signal Names

P2 Pin	Signal Name	Signal Function	P2 Pin	Signal Name	Signal Function
1	CTS	Serial Port	2	TxD	Serial Port
3	RxD	Serial Port	4	GND	Ground
5	Vcc	+5V Power	6		

Table 2. Serial Interface on Connector P2, Pins and Signal Names

Signal Name	DB-9 Pin	J2 Pin	Sourced by	Signal Function
RxD	2	13	ctrl	serial data from controller to host
TxD	3	15	host	serial data from host to controller
CTS	8	16	ctrl	used as "ready to receive", handshake = '0' (POSITIVE) when host may send

Signal electrical characteristics are given in Table 3, and they comply to ANSI/EIA/TIA 232-F.

Table 3. Serial Signal and LED Electrical Characteristics

Parameter	Value	Signals	EIA-232 Subsec.
Source Impedance (Power Off)	> 300 Ω	CTS	2.1.5
Output Voltage, Open Circuit	25 volts, max. ²	RxD, CTS	2.1.6
Output Voltage into test load ³	>5, <15 volts ²	RxD, CTS	2.1.6
Short Circuit Current	<100 mA	RxD, CTS	2.1.6
Transition Characteristics	per EIA-232-E ⁴	RxD, CTS	2.1.7
External LED short circuit current	0.5mA nominal	LED	N/A

¹ Measured with respect to circuit AB, Signal Ground.

² Absolute magnitude.

³ Output voltage measured over the entire range of test load from 3000 ohms to 7000 ohms.

⁴ The transition characteristics comply with ANSI EIA/TIA-232-E while the controller is powered on; during power up and power down some of the criteria will not be met.

Touchscreen Connector, P3, and Signal Descriptions

The touchscreen connector, P3, is a single row by five-position header with 0.025 inch square pins spaced on 0.100 centers, and mates with the receptacle on the Leadingtouch 5W touchscreen cable. The pins are numbered as shown in following Figure. The withdrawal force exceeds 2 lbs.



The touchscreen connector, J3, is a five-position 1mm pitch, SMT, ZIF header, and mates with the FPC connector on the Leadingtouch 5W touchscreen. The pins are numbered as shown in following Figure.

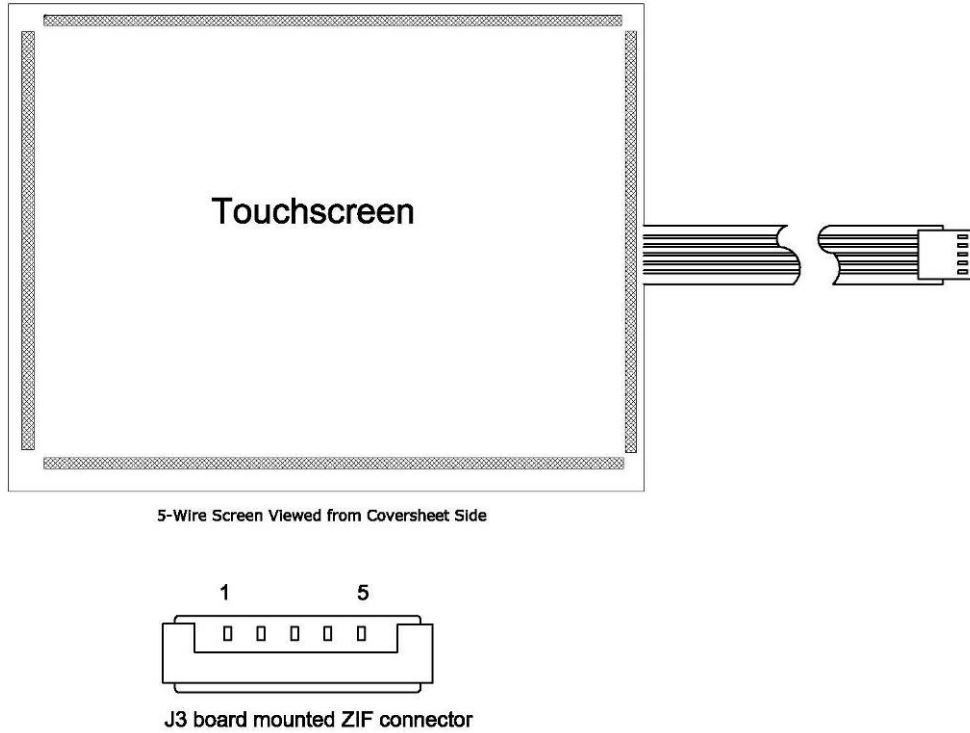

Table 4. Touchscreen Connector, P3 & J3, Pins and Signal Names

P3&J3 Pin	Signal Name	Signal Description
1	H	Drive signal attached to the touchscreen upper right corner when viewed from a user's perspective
2	X	Drive signal attached to the touchscreen lower right corner
3	S	"Sense" signal attached to the touchscreen coversheet
4	Y	Drive signal attached to the touchscreen upper left corner
5	L	Drive signal attached to the touchscreen lower left corner

9 Agency Approvals

The touch system including 5030S controller, touchscreen and connection cable has certified with FCC Part 15.

The touch system including 5030S controller, touchscreen and connection cable is compatible with EN55022 and EN55024 standards and is certified with CE.

10 Installing Driver

Start installation

Double click setup.exe file to start installation.

Firstly install resource kit for driver

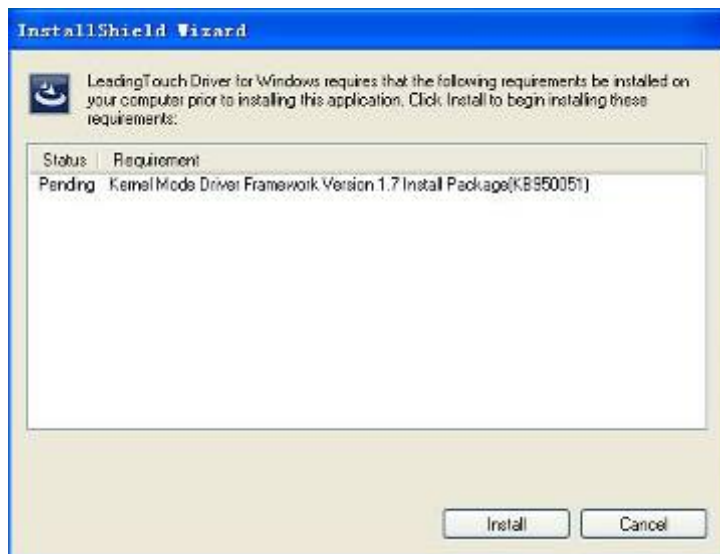

Choose a installation path, the default path is C:\Program files\Leadingtouch.



There are two setup type: complete and Custom. The default one is complete type.



After installation, double click LeadingTouchSetup on desktop to enter calibration program.



Introduction to driver setup and function

Touchscreen administration interface



Language: can choose interface language, now has two choice Chinese and English language.

Touchscreen: All touchscreen can be recognized is shown in the box, choose the right one calibrate and click Setting(S) to continue your setting.

COM Port(P): For serial interface touchscreen, please select the right COM port for your touchscreen to continue setting(Note: COM interface touchscreen can't not be recognized autoly, user need to select COM port manually and click Add to add touchscreen into computer as following picture shows).

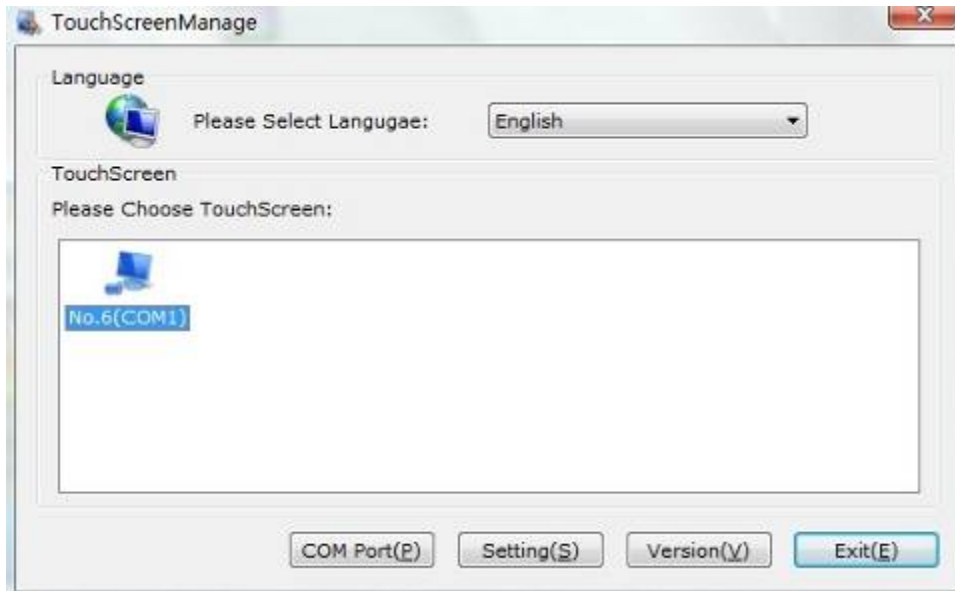

Driver version information



Touchscreen setting

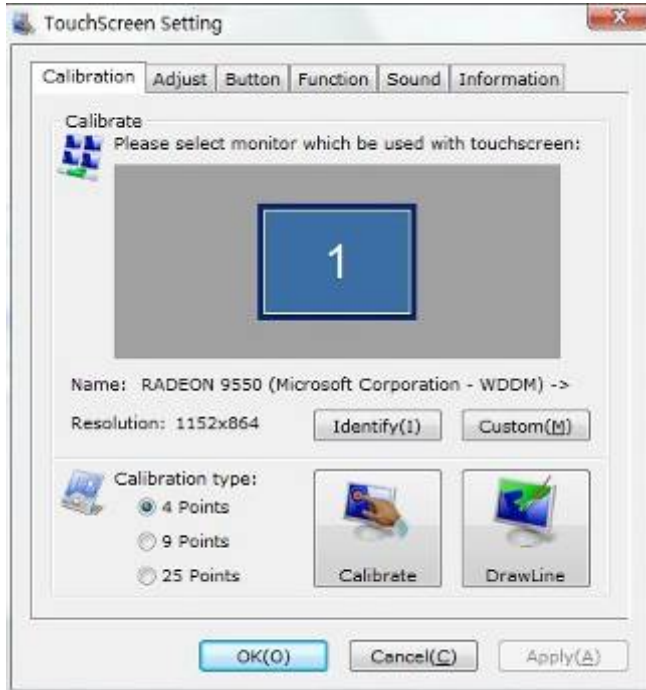

Calibrate: show monitor and resolution information recognized by system

Identify: show monitor information to current touchscreen.

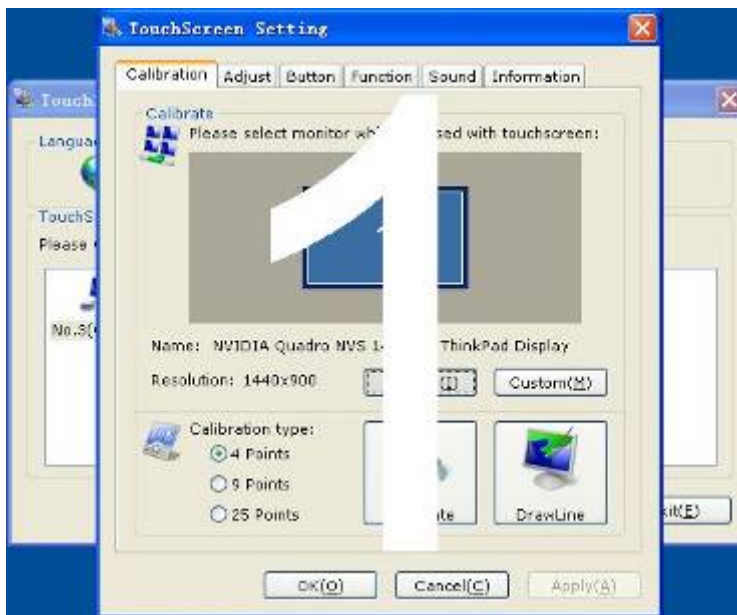

Custom: to define custom calibration area by changing drag Left-Top and Right-Bottom coordinate to set calibration area.

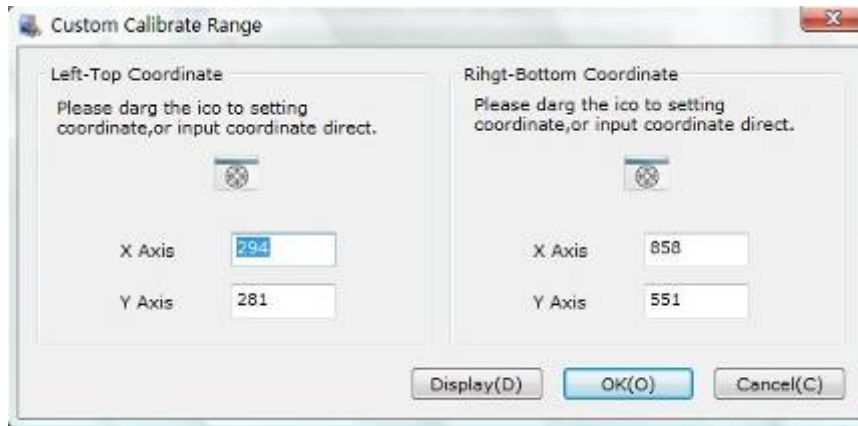

4 points calibration: calibrate by 4 points, for 4 WIRE RESISTIVE and Infrared touchscreens.

9 points calibration: calibrate by 9 points, for 4W, 5W and capacitive touchscreen.

25 points calibration: calibrate by 25 points, for 4W, 5W and capacitive touchscreen.

Select 4 points, 9 points, 25 points or custom and click calibrate to start calibration.



Press the center of red point for about 2-3 seconds. Don't release your finger until the red point shaft to next position or hearing beep sound. Repeat for all red point to finish calibration.

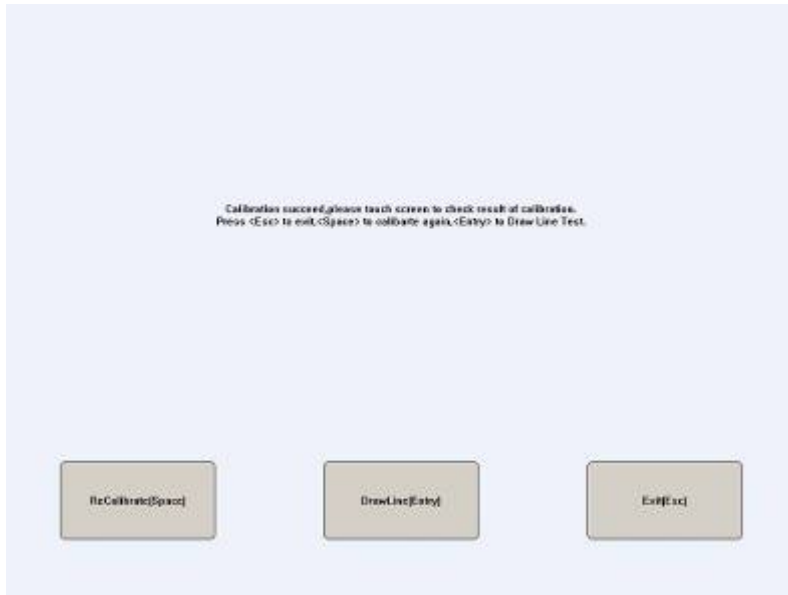

After calibration, you can choose:

Recalibrate: If mouse cursor can't overlap with your touch finger, please select this item to calibrate touchscreen again.

DrawLine: Select to enter draw-line test, for more details refer to next chapter

Touchscreen setting- Adjust

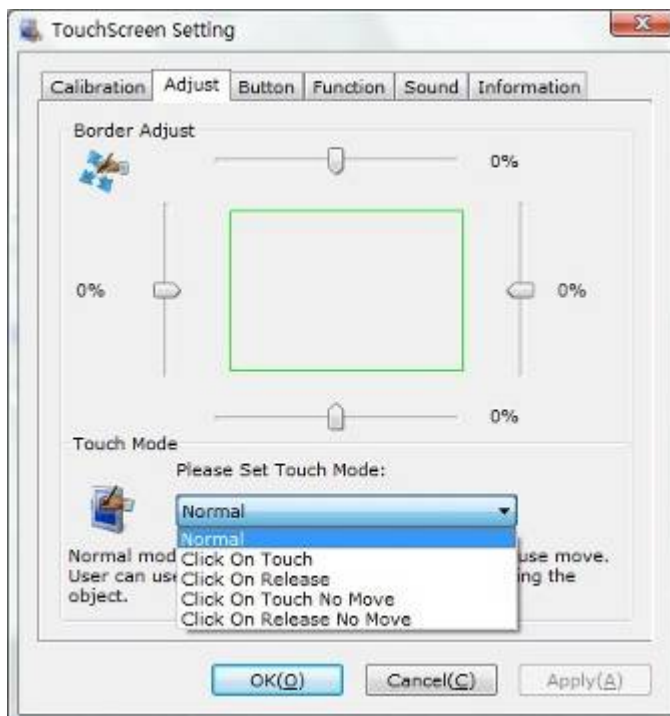

Border adjust: adjust screen border scale border to fit current touchscreen, as touchscreen may have abnormal action caused by installation or non-linear problem.

Touch mode:

Click On Touch: indicates the response when your finger touches on the panel

Click On Release: indicates the response when your finger leaves the touch panel

Click On Touch No Move: indicates the response when your finger touches on the panel, can't draw

line and drag

Click On Release No Move: indicates the response when your finger leaves the panel, can't draw line and drag

Touchscreen setting-Button

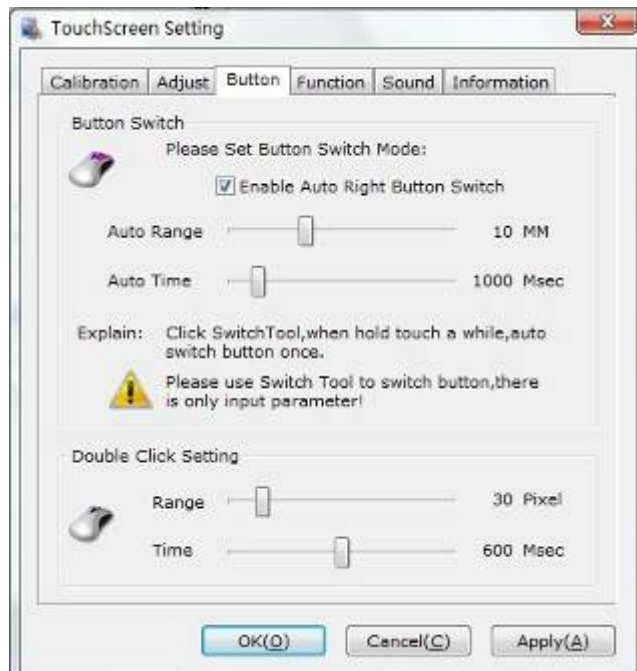

[Button Switch]: Enable Auto Right Button Switch

Auto range: Click effectual in 10mm area

Auto time: Click effectual in 1000mMsec

Auto right button effects only when above two items effectual.

[Double Click Setting]:

Range: Clicks in range of 10 mm are determined to be a touch point

Time: Clicks in 500 msec are determined to be a touch point

If any icon or program can't open normally, please drag the two rules above to right side a little.

Touchscreen setting-Advanced

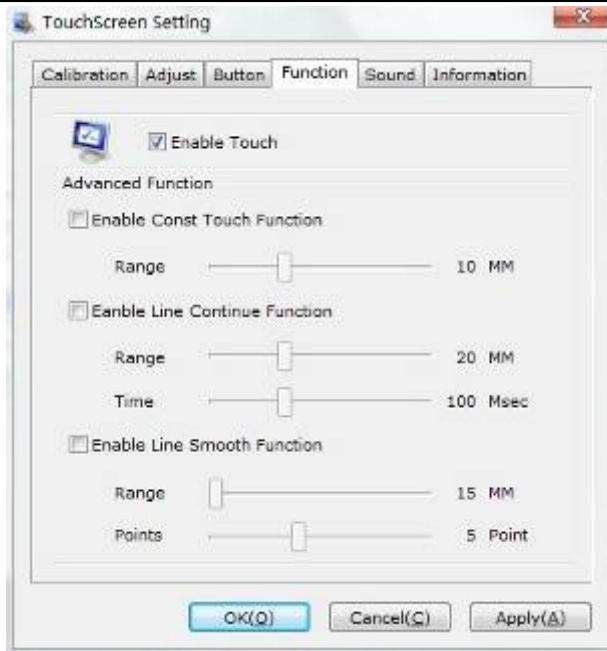

[Enable Touch]: Enable or disable touch function of touch panel

[Advanced Function]:

Enable Const Touch Function: The range of 10 mm are determined to be a touch point

Enable Line Continue Function: Settings for handwriting input or drawing.

Range: Disconnected line in range of 20mm will be amended by algorithm

Time: Disconnected line in range of 100msec will be amended by algorithm

Enable Line Smooth Function: Line can be smoothed by algorithm to insert 5points in 15mm range

Touchscreen setting-Sound

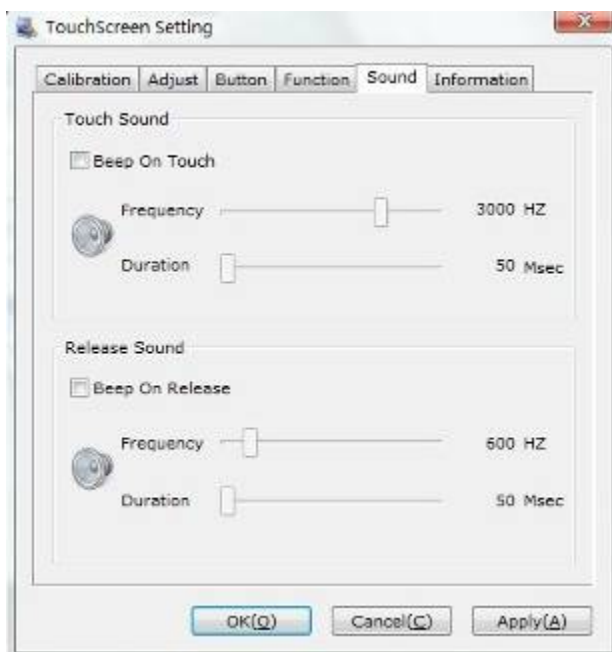

Beep on touch the speaker on the computer will generate voice when touch on the touchscreen

Beep on release the speaker on the computer will generate voice when leave off the touchscreen

Touchscreen setting-Information



[Screen information]

Select: Click to select current touch panel size and model to amending function if mouse cursor not overlap with your finger after calibration. Default size is from 3.5inch to 42 inch

Custom: Click to input a custom touch panel size

[Control Card information]

Indicate Control Card information

Uninstall Leadingtouch drivers

Enter Touchscreen Uninstall program through the following programmer

- 1 Click "Start"----"programmer"----"Leadingtouch" ----"Uninstall"



- 2 Open control panel and select "Leadingtouch Driver for Window" ----"delete"



3. Run setup program and select "uninstall".

11 FAQ

Q: Touchscreen no reaction. LED on control card is constantly on for 3 seconds, then snuff out and be constantly on during touch.

A: Phenomenon below indicates touchscreen and control card are in good condition, you can find out problem as below method.

1: if right driver is installed.

2 : If COM port selected in program is the right one in use.

3 : If Jumper on control card meet current driver.

4 : If COM port of computer can work normally.

5 : If computer COM port is in use by other device.

6 : If there is any mistake information from operating system.

Solution:

1: Install a right driver

2 : Set program COM port as the one in use. 3 : Install a right driver. For jumpers and driver corresponding relationship please refer to Jumper setting description.

4 : Inspect if Serial or USB port is open in mainboard bios file, if there is any hardware problem(can inspect by serial or USB interface mouth).

5 : Change to another serial port or uninstall other device.

6 : Change another host or re-install operating system.

Q Touch no action and LED constantly on.

A This indicate touchscreen and control card are not in good preparation, please check following below steps

- 1 : If front frame interfere with touchscreen active area.
- 2 : If Control card temperature is too high.
- 3 : If cable or control card is broken.

Solution

- 1 : Adjust touchscreen to right position.
- 2 : Remove control card to ventilated environment
- 3 : Change another touchscreen or control card.

Q Touch no reaction, LED flickers.

A That indicate a communication mistake between touchscreen and control card. Please settle it as following steps

- 1 : Check if power supply for control card is unstable.
- 2 : Check if there is water or other dirty on touchscreen.
- 3 : Check if cable connected to touchscreen and control card is loosing.
- 4 : Check if touchscreen and control card is broken.

Solution :

- 1 : Change another host or adopt a stable power.
- 2 : Clean touchscreen and restart computer.
- 3 : Re-connect touchscreen and control card.
- 4 : Change another touchscreen or control card

Q Touch no reaction, LED is off constantly.

A That indicate there is no current through control card. Please check as following steps.

- 1 : Check if 232 or USB cable is not in good condition or connection.
- 2 : Check if power cable is not in good condition.
- 3 : Check if control card is not in good condition.

Solution

- 1 : Re-connect cable or change another cable
- 2 : Change another power cable
- 3 : Change another control card

Q Cursor not move with finger, has deviation.

A This is caused by inaccurate calibration, please check according to following directions.

- 1 : Check if calibrate touchscreen uncorrectly.
- 2 : Check if changed resolution without re-calibration
- 3 : Check if jumper setting on control card meets current driver
- 4 : Check if touchscreen is dirty
- 5 : Check if control card temperature is too high to work normal, and if there is influence from other high frequency device.
- 6 : Check if touchscreen and control card is in good condition

Solution

- 1 : Redo calibration test, be sure let your finger overlap with red circle center in calibration
- 2 : Redo calibration test
- 3 : Setup right jumper and driver and redo calibration
- 4 : Clean touchscreen
- 5 : Remove control card to low temperature and influence place
- 6 : Change another touchscreen or control card

Q: Cursoer can't move, LED flickerss

A: This usually caused by software mistakes, please solve it as following instructions

- 1 : Check if calibrate uncorrectly
- 2 : Check if jumper setting on control card meets current driver
- 3 : Check if there is water or other contamination on touchscreen surface, or host is hang over
- 4 : Check if adopt unqualified dust-proof strips or assemble touchscreen uncorrectly.

Solution:

- 1 : Redo calibration
- 2 : Make certain driver is correct installed and redo calibration
- 3 : Clean touchscreen and restart computer
- 4 : Adopt qualified dust-proof strips and assemble it not too tight